

GRAPHTEC

Modular Type Data Acquisition Unit

DATA PLATFORM GL7000

To measure the selected signal on demand with the selected number of channels and time interval
The next generation Data Acquisition unit



Embedded in the device to create the system



Connected to the PC for measuring with the GL7000 (no display module)

Suitable for a variety of measurements due to flexible module combinations

Voltage Module

- The output of various sensors such as displacement, pressure, wind speed, etc. Cell voltage of the battery.

Voltage/Temperature Module

- Measuring temperature and voltage simultaneously. For environmental tests, etc.

High Speed Voltage Module

- Measurement of parameters in the inverter system, vibration test, drop test, etc.

Logic/Pulse Module

- Timing of system control signal, encoder output, rotational speed, flow rate, etc.

High Voltage Module

- Measurement of the high voltage in the power line of equipment. Electric or Hybrid Vehicle testing, etc.

Charge Module

- Measuring the output of sensor using the Piezoelectric device. Measurement of the vibration, acceleration, pressure, force, etc.

Voltage Output Module

- An analog voltage corresponding to the captured data is output. Simulation testing by the actual measured data, the vibration test, etc.

Power Measurement Module

- Measuring the voltage, current and power. Measurement of the power line of the device, etc.

DC Strain Module

- Measuring the output of sensor using the strain gauge. Measurement of the load, displacement, vibration, acceleration, torque, pressure, etc.

Modules will be released sequentially starting in the autumn of 2012

GL7000 specifications	
Item	Description
Number of module	Attached to up to 10 modules *1
Number of input channels	Max. 112 channels in one GL7000
External Input/Output signals *2	Input Start/Stop, Trigger, External sampling, Auto balance Signal type: Contact (relay), Open collector, Voltage
	Output Trigger: Busy, Alarm (10 channels) *3 Signal type: Open collector (pulled-up by resistor 10 k ohms)
Trigger, Alarm function	Trigger action Start or stop capturing data by the trigger
	Trigger repeat Enabled (ON): Automatically rearm for the next data capture Disabled (OFF): Data capture is completed in a single trigger
	Trigger condition Start: Off, Measured signal, Alarm, External, Clock, Week or Time Stop: Off, Measured signal, Alarm, External, Clock, Week or Time
	Trigger determination conditions for measured signal Combination: OR or AND condition at the level of signal or edge of signal Logic *4: Higher/Rising, Lower/Falling, Window-in, Window-out Pulse *4: Higher/Rising, Lower/Falling, Window-in, Window-out
	Alarm determination condition *5 Combination: OR or AND condition at the level of signal or edge of signal Logic *4: Higher/Rising, Lower/Falling, Window-in, Window-out Pulse *4: Higher/Rising, Lower/Falling, Window-in, Window-out
	Alarm output 10 channels
Pre-trigger *6	Number of data before trigger. Up to specified number of captured data
Calculation function	Between channels Addition, Subtraction, Multiplication and Division for two analog inputs (Sampling speed is limited up to 10 Samples/s (100ms interval). Available arithmetic element and the output destination is the analog input channel 1 to 100.)
	Statistical Select two calculations from Average, Peak, Max., Min. in real time and replay *7
Move function of the display range	Beginning, center or end of the data, Trigger point, Specific time (absolute, relative), Call cursor
Search function	Search for analog signal levels, logic signal pattern, pulse signal levels or alarm point in captured data
Annotation function	Comment can be set in each channel (up to 31 alphanumeric characters)
Message, Marker function	Message: Record up to 8 messages in any timing (Any message can be set before data capture is started or during data capture.) Marker: Recorded when the trigger, alarm or a power failure occurs
Resume	Resume automatically in the same condition after power is recovered as when the power failure occurred during data capture *8
Interface to PC	Ethernet (10 BASE-T/100 BASE-TX), USB 2.0 (High speed)
Network function	WEB server, FTP server, FTP client, NTP client, DHCP client
USB drive mode	Emulate the USB memory device *9
Storage device	Built-in RAM (2 million samples, built-in Signal conditioning module), Flash memory (2 giga-bytes, built-in the main module)
	External *10 SD card (Support SDHC, up to 32 GB) slot, SSD (Approx. 64 GB) The file for capturing data is limited up to 2 GB.
Data saving function	Captured data *10 Built-in RAM, Built-in Flash, SD memory card, SSD (Data is saved directly to it.)
	Data in built-in RAM Specified number of data up 2 million samples in increments of 1
	Ring capturing mode *10 *11 Saves most recent data Number of capturing data: 1000 to 2000000 points Destination of data: Built-in RAM, Built-in Flash, SD memory card, SSD
	Backup *10 Backup interval: Off, 1, 2, 6, 12, 24 hrs. Data destination: SD memory card, SSD, FTP server
Engineering Scale function	Measured value can be converted to the engineering unit Analog voltage: Converts by four reference points (gain, offset) Temperature: Converts by two reference points (offset) Pulse count: Converts by two reference points (gain)
Synchronization between units	Start and Trigger *12
Accuracy of clock	±0.002 % (Monthly deviation approx. 50 sec.) (at 23 °C)
Operating environment	0 to 45 °C, 5 to 85 % RH (non condensed)
Power source	100 to 240 V AC, 50/60 Hz
Power consumption	Approx. 85 VA
Standard accessories	Quick guide, CD-ROM, AC power cable
External dimensions (W x D x H)	Main module: Approx. 193 x 141 x 160 mm (Excluding Projection), Alarm output terminal: Approx. 30 x 136 x 145 mm (Excluding projection)
Weight	Main module: Approx. 2 kg, Alarm output terminal: Approx. 350 g

Software specifications	
Model name	GL-Connection
Supported OS	Windows 7 (32/64-bits, Except Starter edition), Vista (32/64-bits), XP *13
Functions	Control GL7000, Real-time data capture, Replay data, Data format conversion
Controlled units	Up to 10 units (Max. 1120 channels)
GL7000 Settings control	Input settings, Memory settings, Trigger and Alarm settings, Other settings
Captured data *14	Built-in RAM (Binary format), Built-in Flash memory (Binary, CSV format), SD memory card (Binary, CSV format), SSD (Binary, CSV format) The sampling is limited by the number of channels used. (1 ms per channel. When 10 channels are set, sampling is limited to 10 ms.)
Displayed information	Analog waveforms, Logic waveforms, Pulse waveforms, Digital values
Display mode	Y-T waveform with digital values, X-Y graph in real time, Cursor information, Capture condition, Alarm information
File operation	Converts binary data to the CSV data (specific period, all data in one file, multiple files). Creates a new file with compression or by consolidating multiple files.
Warning Function	Send e-mail to the specified address when the alarms occur
Statistical calculation	Capturing data: Maximum, Minimum, Peak or Average Replaying data: Maximum, Minimum, Peak, Average or RMS in between cursors
Search function	Level Specific level in any channels
	Alarm Occurred alarm in any channel
	Time Beginning, center, end of the data, Trigger point, Specific time (absolute, relative), Specific number
Operation lock	Operation screen can be locked (It is unlocked with a password.)

Brand names and product names listed in this brochure are the trademarks or registered trademarks of their respective owners. Specifications are subject to change without notice.

GRAPHTEC
Graphtec Corporation

503-10 Shinano-cho, Totsuka-ku, Yokohama 244-8503, Japan
Tel : +81-45-825-6250 Fax : +81-45-825-6396
Email : webinfo@graphtec.co.jp

Website <http://www.graphteccorp.com>

Display module specifications	
Model name	GL7-DISP
Display device	5.7-inch TFT color LCD monitor (VGA: 640 x 480 dots)
Operation section	Touch panel and Cursor keys *15
Touch panel	Capacitive type touch panel. Operated by finger or the proprietary pen
Displayed language	English, French, German, Chinese, Korean, Japanese
Screen saver	Turns off backlight by 10, 30 sec., 1, 2, 5, 10, 30, 60 min
Displayed information	Waveform in Y-T with digital values, Waveform only, Digital value, Waveform in X-Y
Connection cable	LAN cable (CAT5 class, Straight connection, Up to 10m) *16
Standard accessories	Bracket for slanted mount, Connection cable (40cm), Ground cable, Screws
External dimensions (WxDxH)	Approx. 187 x 35 x 199 mm (Excluding projection)
Weight	Approx. 530 g

SSD module specifications		
Model name	GL7-SSD	
Memory device	Solid state disk (SSD), Form factor: 2.5-inch HDD	
Capacity	Approx. 64 GB (The file size of the captured data is limited up to 2 GB.)	
Sampling speed *17	Attached to 1 or 2 modules	Max. 1 M Samples/s
	Attached to 3 or 4 modules	Max. 500 k Samples/s
	Attached to 5 or 10 modules	Max. 200 k Samples/s
External dimensions (WxDxH)	Approx. 49 x 136 x 160 mm (Excluding projection)	
Weight	Approx. 770 g	

Options and accessories		
Item	Model number	Remarks
Input/Output cable	B-513	2m, One end is bare wire
Humidity sensor	B-530	3m cables for signal and power
Sync cable	B-559	1m, Synchronizing between GL7000
Probe set for Logic input	RIC-10	4 channels, Cable with Alligator clip and IC clip
Input cable, BNC - BNC	RIC-112	1.5m, Non-Isolated, Max. 500V
Input cable, Banana - BNC	RIC-113	1.5m, Non-Isolated, Max. 500V
Input cable, Banana - BNC	RIC-114	1.5m, Non-Isolated, Max. 500V
Input cable, BNC - BNC	RIC-142	1.5m, Isolated, CAT II, Max. 1000V
Input cable, Banana - BNC	RIC-143	1.5m, Isolated, CAT II, Max. 600V
Clip, Alligator (small size)	RIC-144	CAT II, Max. 300V/15A, using with RIC-143
Clip, Alligator (middle size)	RIC-145	CAT II, Max. 1000V/32A, using with RIC-143
Clip, Grabber	RIC-146	CAT II, Max. 1000V/1A, using with RIC-143

Notes:

- Excluding the function module as the Display module or SSD module.
- The Input/Output cable (B-513) is required for connecting the signal. The Autobalance signal input and the Busy signal output are used in the DC Strain Module.
- The alarm signals are output on the terminal block attached to the main module as standard accessory.
- It is available on the Logic/Pulse module.
- Method of detection
Volt/Temp. module: The alarm is detected in the sampling interval when the sampling interval is shorter than 5 seconds. The alarm is detected every 5 seconds when the sampling interval is longer than 5 seconds.
Other modules: The alarm is detected every 1ms when the sampling interval is shorter than 1ms. The alarm is detected in the sampling interval when the sampling interval is set between 2ms to 5 seconds. The alarm is detected every 5 seconds when the sampling interval is longer than 5 seconds.
- It is available when the captured data is saved to the built-in RAM. The pre-trigger function may not work in combination with the trigger settings.
- The result of real time calculation is displayed in the digital display mode.
- When the captured data destination is set to the built-in-RAM, the captured data is not maintained after a power failure. The built-in Flash or the SD memory card may be damaged by a power failure if it is being accessed to write data. If the memory device is not damaged, the closed data file is maintained. The file is closed every one minute while data is being captured.
- The USB drive mode is started by setting of the switch on the main module. It can be also started when the power is turned on while pressing the key on the display module.
- The SD memory card is not included as a standard accessory. The SSD module is an option.
- The capacity for saving the data is set to one third of available memory when the captured data destination is set to a device other than the built-in-RAM. The sampling speed is limited up to 10 samples (100ms interval).
- The Sync cable (B559) is required when this function is used. The GL-Connection software is required when the synchronizing function is used.
- The SP2 or higher service pack need to be installed.
- The captured data that is saved to the built-in-RAM or SSD cannot be saved to the PC in real time. The data in the built-in-RAM or SSD needs to be transferred to the PC after data capture is complete.
- Most operations can be selected by both the touch panel and keys.
- When the display module is mounted at an angle using the bracket, the display module is connected to the main module by a LAN cable that is attached to the display module as a standard accessory.
- The sampling speed in the GL7000 is limited to the fastest sampling speed of attached signal conditioning module. When the specified sampling speed is faster than the module, the sampling is done in fastest sampling on the module. The same value is stored to the memory device in the specified sampling speed until data is renewed by the next sampling.

RoHS Compliant model



ER231205_AD Vol.09

www.graphteccorp.com

The new generation data acquisition unit
 It can measure the desired signal according to the needs and can expand into other applications adding different amplifier modules. It can be attached to a display module having a touch panel, used as a stand-alone unit or embedding into a system.



The number of channels and measurement types can be added to the amplifier module



The amplifier module can be expanded to accommodate a wide variety of measurements

A wide variety of measurements can be supported by the amplifier module

Measurements for different applications can be added to the amplifier module. It is also possible to mix measurements by adding different types of modules.

Amplifier can be attached to up to 10 modules

Up to 10 amplifier modules can be attached for multi-channel measurements, with up to 112 channels on one GL7000.



Maintains sampling speed even if the number of amplifier modules are increased

Voltage* and Volt/Temp amplifier can maintain high-speed and multichannel measurements without dropping the sampling speed, even if the number of modules are increased.

* In the High-speed voltage and Logic/Pulse module, the sampling speed will be limited by the recording medium.

Volt./Temp. module being used	10 ch being used, Maximum sampling speed 100S/s (10ms interval)	
	20 ch being used, Maximum sampling speed 100S/s (10ms interval)	
	40 ch being used, Maximum sampling speed 100S/s (10ms interval)	
	100 ch being used, Maximum sampling speed 100S/s (10ms interval)	

Amplifier Module	Channels in 1 module	Max. sampling speed in the module	Media type to save data		Max. sampling speed in the GL7000	
			Attached to 1 or 2 modules	Attached to 3 or 4 modules	Attached to 5 or 10 modules	Attached to 10 or 20 modules
Voltage Module	10 ch	1 k Samples/s (1ms interval)	Built-in RAM	1 k Samples/s (1ms interval)	1 k Samples/s (1ms interval)	1 k Samples/s (1ms interval)
			Built-in Flash	1 k Samples/s (1ms interval)	1 k Samples/s (1ms interval)	1 k Samples/s (1ms interval)
			SD card	1 k Samples/s (1ms interval)	1 k Samples/s (1ms interval)	1 k Samples/s (1ms interval)
Volt./Temp. Module	10 ch	100 Samples/s (10ms interval)	Built-in RAM	100 Samples/s (10ms interval)	100 Samples/s (10ms interval)	100 Samples/s (10ms interval)
			Built-in Flash	100 Samples/s (10ms interval)	100 Samples/s (10ms interval)	100 Samples/s (10ms interval)
			SD card	100 Samples/s (10ms interval)	100 Samples/s (10ms interval)	100 Samples/s (10ms interval)
High-speed voltage Module	4 ch	1 M Samples/s (1µs interval)	Built-in RAM	1 M Samples/s (1µs interval)	1 M Samples/s (1µs interval)	1 M Samples/s (1µs interval)
			Built-in Flash	1 M Samples/s (1µs interval)	1 M Samples/s (1µs interval)	1 M Samples/s (1µs interval)
			SD card	1 M Samples/s (1µs interval)	1 M Samples/s (1µs interval)	1 M Samples/s (1µs interval)
Logic Pulse Module	16 ch	1 M Samples/s (1µs interval)	In Logic mode	1 M Samples/s (1µs interval)	1 M Samples/s (1µs interval)	1 M Samples/s (1µs interval)
			In Pulse mode	1 M Samples/s (1µs interval)	1 M Samples/s (1µs interval)	1 M Samples/s (1µs interval)
			In Logic mode, 10 k Samples/s (100µs interval)	10 k Samples/s (100µs interval)	10 k Samples/s (100µs interval)	10 k Samples/s (100µs interval)

*1: Using in Logic mode, the module can be attached up to 7 units.
 *2: Using in Pulse mode, module can be attached up to 2 units.
 *3: SSD module is an option. Number of channels for pulse input will be limited when the High-speed voltage module and Logic/Pulse module are used simultaneously.

Multi-channel measurement is possible to 1120 channels using the PC
 Up to 10 units of the GL7000 can be connected to 1 PC through LAN or USB and controlled using the software.

Up to 5 units of the GL7000 can be fully synchronized using the sync. cable
 The start/stop trigger, and sampling can be synchronized in the GL7000 when they are connected by a sync cable. The master and slave units are automatically identified.

Attaching the high-definition display module with touch panel allows stand-alone operation or embedding into a system

The detachable display module allows both stand-alone and embedded system configurations

Measurement settings and signal measurement can both be done without a PC by attaching the display module. The display module can be moved to different locations for remote operation by connecting it to the main module with a LAN cable*, it also can be embedded into the system. The module can still be operated by the PC even when the display module is connected.

* Up to 10m using CAT5 LAN cable (straight connection)

Improved ease-of-use with the high-definition display and touch panel

The touch panel makes setting the conditions intuitive, and it can also be operated using the cursor keys similar to the GL series.



Can also be set using the cursor keys

Large easy-to-read 5.7-inch high-definition LCD monitor

Utilises a bright clear 5.7 inch wide TFT color LCD monitor (VGA: 640 x 480 dots). Makes it easy to read data in wave form or digital form and to check measurement parameter settings.

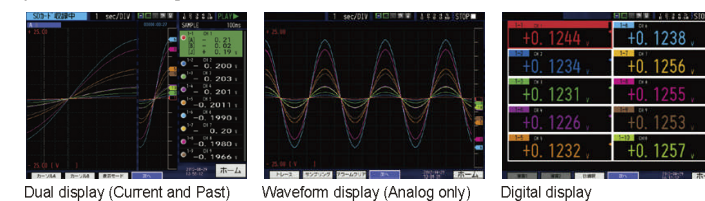

Support interface friendly with the PC

Ethernet (10BASE-T, 100BASE-TX) and USB2.0 (Hi-speed) interface are standard. Each interface port is located in the front of the unit for easy cable connection.

WEB and FTP server function

It can be controlled by using a WEB browser such as Internet Explorer. It also supports monitoring the signal and accessing the captured data in memory devices such as the built-in Flash, SD card* and SSD*.
 *SD memory card is not included as standard accessory. SSD module is an option.

FTP client function

Captured data is periodically transferred to the FTP server for backup.

DHCP client function

The IP address of the GL7000 is automatically obtained from the DHCP server.

USB drive mode

GL7000 can emulate an external USB device for quick data file transfer when it is started in the USB drive mode. The file in the built-in Flash or the SD card can be transferred or deleted from the PC.

NTP client function

The clock on the GL7000 is periodically synchronised with the NTP server.

Supports four destinations to save the captured data according to the conditions of the measurement

1 Built-in RAM

The RAM to save 2 million samples is built into each amplifier module. The captured data can be saved directly to the SD memory card when the sampling is not faster than 1ms (sampling speed: 1 k Samples/s). It supports hot-swap, so the SD memory card can be replaced during measurement without data loss.* The captured data can be transferred easily to the PC in offline condition.

3 SD memory card

SD card slot (supports SDHC, up to 32GB) is standard on the main module. The captured data can be saved directly to the SD memory card when the sampling is not faster than 1ms (sampling speed: 1 k Samples/s). It supports hot-swap, so the SD memory card can be replaced during measurement without data loss.* The captured data can be transferred easily to the PC in offline condition.

* The hot-swap is possible when the sampling is slower than 100ms.

2 Built-in Flash memory

The 2GB of Flash memory is built into the main module. The captured data can be saved directly to the built-in Flash memory when the sampling is not faster than 1ms (sampling speed: 1 k Samples/s). Saved data is retained even when power is turned off because flash memory is used.

4 SSD module (64GB) Option

Allows large amounts of data to be quickly saved when the optional SSD module is attached. The captured data can be saved directly to the SSD when the sampling is not faster than 1µs (sampling speed: 1 M Samples/s). It has a high vibration resistance and saved data is also retained even when power is turned off.

* The number of modules are limited.



Retain the data even if power is off
 High vibration resistance
 High-speed access

Capturing times

Amplifier Module	Storage Device	Device Capacity	Total number of ch.	Single module attached						10 modules attached												
				Sampling speed (interval)						Sampling speed (interval)												
Voltage Module	Built-in RAM	2 M samples	10	1 M S/s (1µs)	500 k S/s (2µs)	200 k S/s (5µs)	1 k S/s (1ms)	100 S/s (10ms)	1 S/s (1s)	100	1 M S/s (1µs)	500 k S/s (2µs)	200 k S/s (5µs)	1 k S/s (1ms)	100 S/s (10ms)	1 S/s (1s)						
				N/A	N/A	N/A	33 min.	5 hrs.	23 days								33 min.	5 hrs.	23 days			
				N/A	N/A	N/A	21 hrs.	8 days	893 days								2 hrs.	24 hrs.	103 days			
				N/A	N/A	N/A	22 hrs.	9 days	956 days								2 hrs.	26 hrs.	111 days			
Volt./Temp. Module	Built-in RAM	2 M samples	10	1 M S/s (1µs)	500 k S/s (2µs)	200 k S/s (5µs)	1 k S/s (1ms)	100 S/s (10ms)	1 S/s (1s)	100	1 M S/s (1µs)	500 k S/s (2µs)	200 k S/s (5µs)	1 k S/s (1ms)	100 S/s (10ms)	1 S/s (1s)						
				N/A	N/A	N/A	5 hrs.	23 days	5 hrs.								23 days					
				N/A	N/A	N/A	8 days	893 days	24 hrs.								103 days					
				N/A	N/A	N/A	9 days	956 days	26 hrs.								111 days					
High-speed Voltage Module	Built-in RAM	2 M samples	4	1 M S/s (1µs)	500 k S/s (2µs)	200 k S/s (5µs)	1 k S/s (1ms)	100 S/s (10ms)	1 S/s (1s)	40	1 M S/s (1µs)	500 k S/s (2µs)	200 k S/s (5µs)	1 k S/s (1ms)	100 S/s (10ms)	1 S/s (1s)						
				2 sec.	4 sec.	10 sec.	33 min.	5 hrs.	23 days								2 sec.	4 sec.	10 sec.	33 min.	5 hrs.	23 days
				N/A	N/A	N/A	39 hrs.	16 days	1660 days								5 hrs.	53 hrs.	223 days			
				N/A	N/A	N/A	42 hrs.	17 days	1775 days								5 hrs.	57 hrs.	239 days			

*1: The capturing time figures are approximate.
 *2: The file size of the captured data is limited up to 2GB.

Software for high performance and easy operation

The GL7000 can be controlled by the GL-Connection software that is included. The software has convenient functions such as saving data to the PC, replaying captured data, and converting data form. It is an integrated application software for the GL series, the GL900, GL820 and GL220 can also be connected.*

*The version for supporting other GL series will be available in December 2012.

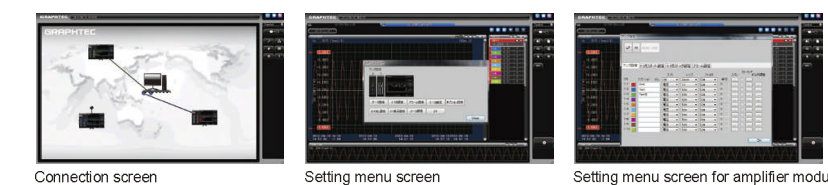

Various measurement screens

The measurement signal can be displayed as various types of screens by the unit, the module or the specific channels that are specified in the group function. It can also be displayed as a combination of the capturing data and captured data, the Y-T format and the X-Y format, simultaneously. Up to 112 channels can be displayed in each window.*

* In case of using dual screen, total 244 channels can be displayed.

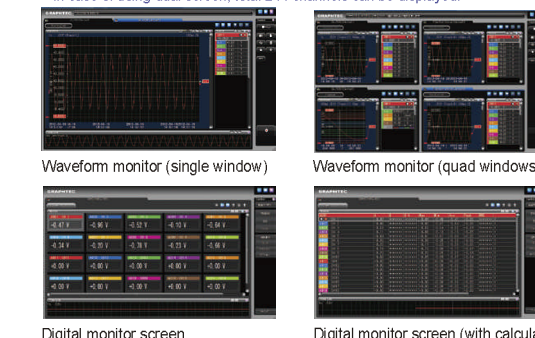

Multi-window function, measured waveform can be displayed in various forms using multiple windows

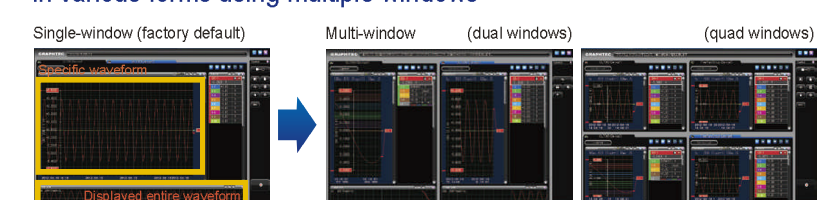





The complete measured waveform can be displayed on one screen. Displayed items in each window can be specified by the unit, the module, or channels. (ex. waveform measured in the each unit is displayed in the separate screens.)

Useful functions For real time and the post processing.

- **Statistical calculation**..... The maximum, minimum, peak, and average values are displayed while capturing data. The value between the cursors of the maximum, minimum, peak, average, and RMS will be displayed when replaying captured data.
- **File operation**..... The data can be converted to the CSV format for a specified period, all data, or multiple files. A file can also be created by compressing or consolidating multiple files.
- **Search**..... The search point can be set by the level, alarm, or time (the beginning of the data, center, end, trigger point, the specified time, instruction time, the number specified).
- **Send mail**..... Alarm warnings can be sent via Email.

Amplifier Module

Amplifier Module

Module	Voltage	High Speed Voltage	Voltage/Temperature	Logic/Pulse
Model number	GL7-V	GL7-HSV	GL7-M	GL7-L/P
Module image				
Number of input channels	10 channels	4 channels	10 channels	16 channels
Input terminal	Screw terminal (M3)	BNC connector	Screw terminal (M3)	Circular connector (10 position, socket)
Input method	All channels isolated unbalanced input, simultaneous sampling		All channels isolated balanced input, scanning channels for sampling	All channels common ground, simultaneous sampling
Sampling speed	1 k Samples/s to 1 Sample/h (1ms to 1hr. interval)	1 M Samples/s to 1 Sample/h (1µs to 1hr. interval)	100 Samples/s with 1-10ch to 1 Sample/h (10ms with 1-10ch to 1hr. interval)	Logic mode: up to 1 M Samples/s (1µs interval) Pulse mode: up to 10 k Samples/s (100µs interval)
Measurement range	100mV to 100V F.S., and 1-5V F.S.		Volt.: 20mV to 50V F.S., and 1-5V F.S. Temp.: Thermocouple: K, J, E, T, R, S, B, N, W (WRe5-26) RTD: Pt100 (IEC751), Pt1000 (IEC751), Pt100J (JIS)	Bi-level signal, up to 24V Select either Logic or Pulse mode Logic: Signal pattern Pulse: Counting in Instant, Accumulating, Rotation (max. 15 million count)
A/D converter	Successive Approximation, 16 bits		Sigma-delta, 16 bits	
Maximum Voltage	Between channels: 1000 V, 1 min. Between inputs and GND: 1000 V, 1 min.		Between channels: 350 V, 1 min. Between inputs and GND: 350 V, 1 min.	
Built-in RAM	2 million samples			

Combinations of amplifier modules

Simple measurement with a single module

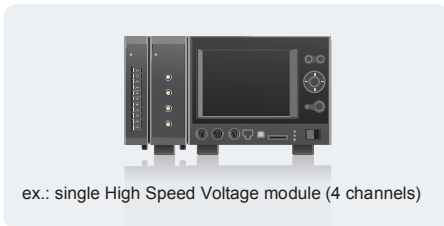

Variety of measurements with different amplifier modules

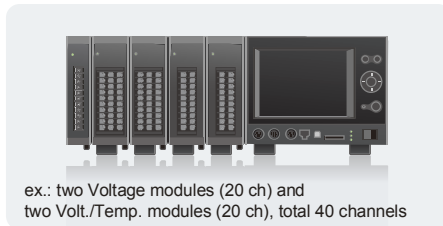

Multi-channel measurement with several amplifier modules

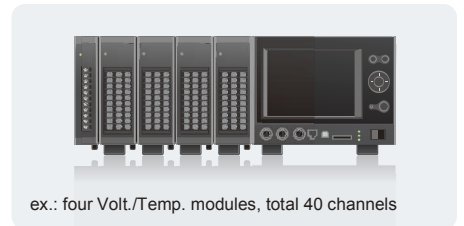

Typical applications

Example: **Batteries** / UPS (Uninterruptible Power Supply) test

Evaluation testing for the charging current, the output voltage with discharge capacity, etc.

Advantages

- Supports long term measurement with high-speed sampling
- Higher voltage capability
- Expandable with additional modules

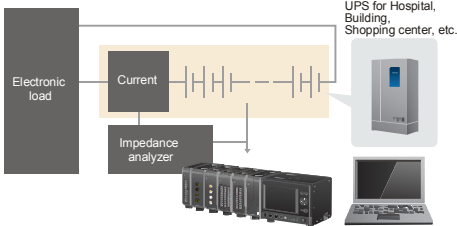

UPS for Hospital, Building, Shopping center, etc.

Voltage measurement in each cell, 60 ch to 80 ch

Example: **Vehicles** / Bearing durability test

Utilized in temperature, vibration and other testing to check the durability of the bearings that are used in extreme temperature and vibration conditions.

Advantages

- Supports low- to high-speed sampling
- Very large storage
- Expandable with additional modules
- PC compatible

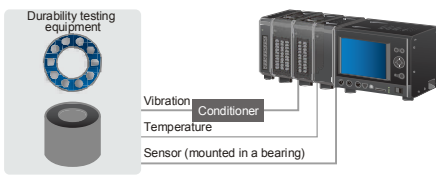

Bearings for cars: Power steering, Engines, Hub Units, Alternators, etc.

Example: **Appliance** / Washer-dryer evaluation test

Used to measure various evaluation items such as the temperature, flow rate, air volume, sound, vibration, etc. using multi-type input and low- to high-speed sampling.

Advantages

- Maintaining the sampling speed in the multi-channel
- Supporting a variety of measurements due to flexible module combinations
- Very large storage

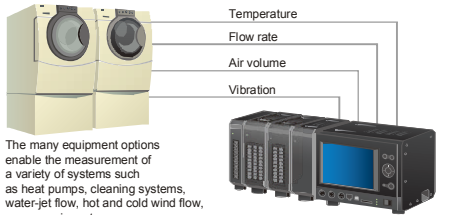

The many equipment options enable the measurement of a variety of systems such as heat pumps, cleaning systems, water-jet flow, hot and cold wind flow, power-saving, etc.

Example: **Vehicles** / Automobile battery test

Utilized to measure the charge and discharge characteristics of the battery in vehicles that have energy saving controls such as idling-stop, etc..

Advantages

- Supports long term sampling
- Supports reconfiguration to fit the desired measurement
- PC compatible

Example: **Others** / Chassis dynamometer test

Capturing various data such as the torque, etc. by the driving pattern

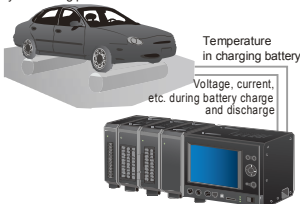

Temperature in charging battery
Voltage, current, etc. during battery charge and discharge

Example: **Others** / Geothermal test

Used for demonstration and evaluation testing of new air conditioning systems that utilize a geothermal heat pump for heat exchange.

Advantages

- Support embedding into a system
- Supports various amplifier modules
- Monitoring on PC using software
- Very large storage

Outside air temperature, Room temperature, Intake of the heat pump, Exhaust of the heat pump, etc., where more than 20ch are required.

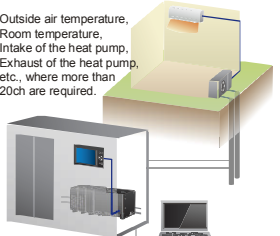

Voltage/Temperature Module Specifications				
Model number	GL7-M			
Number of input channels	10 channels			
Input method	All channels isolated balanced input, Scans channels for sampling, Screw terminal (M3 screw)			
Sampling speed	100 Samples/s with 1-10ch to 1 Sample/h (10 ms at 1-10ch to 1 hr. interval)			
Measurement range	Voltage	20, 50, 100, 200, 500 mV, 1, 2, 5, 10, 20, 50 V, and 1-5 V/F.S.		
	Temperature	Thermocouple: K, J, E, T, R, S, B, N, and W (WRe5-26), RTD: Pt100, JPt100(JIS), Pt1000(IEC751)		
	Humidity *1	0 to 100 % (using scanning function in 5V range, humidity sensor B-530)		
Measurement accuracy*2	Voltage	± 0.1 % of F.S.		
	Temp- Thermocouple	Measurement range		
R/S	0 °C ≤ TS ≤ 100 °C		± 5.2 °C	
	100 °C < TS ≤ 300 °C		± 3.0 °C	
	R: 300 °C < TS ≤ 1600 °C		± (0.05 % of reading + 2.0 °C)	
	S: 300 °C < TS ≤ 1760 °C		± (0.05 % of reading + 2.0 °C)	
	B		400 °C ≤ TS ≤ 600 °C	± 3.5 °C
	600 °C < TS ≤ 1820 °C		± (0.05 % of reading + 2.0 °C)	
	K		-200 °C ≤ TS ≤ -100 °C	± (0.05 % of reading + 2.0 °C)
	-100 °C < TS ≤ 1370 °C		± (0.05 % of reading + 1.0 °C)	
	E		-200 °C ≤ TS ≤ -100 °C	± (0.05 % of reading + 2.0 °C)
	-100 °C < TS ≤ 800 °C		± (0.05 % of reading + 1.0 °C)	
	T		-200 °C ≤ TS ≤ -100 °C	± (0.1 % of reading + 1.5 °C)
	-100 °C < TS ≤ 400 °C		± (0.1 % of reading + 0.5 °C)	
	J		-200 °C ≤ TS ≤ -100 °C	± 2.7 °C
	-100 °C < TS ≤ 100 °C		± 1.7 °C	
	100 °C < TS ≤ 1100 °C		± (0.05 % of reading + 1.0 °C)	
N		0 °C ≤ TS ≤ 1300 °C	± (0.1 % of reading + 1.0 °C)	
W		0 °C ≤ TS ≤ 2000 °C	± (0.1 % of reading + 1.5 °C)	
Reference Junction Compensation (R.J.C.) accuracy: ± 0.5 °C *3				
R.J. Compensation	Measurement range	Driving current	Accuracy	
	Pt100	-200 °C to 850 °C (FS = 1050 °C)	1 mA	± 1.0 °C
	JPt100	-200 °C to 500 °C (FS = 700 °C)	1 mA	± 0.8 °C
	Pt1000	-200 °C to 500 °C (FS = 700 °C)	0.2 mA	± 0.8 °C
Selecting of the internal or external Sigma-Delta type, 16 bits (effective resolution: 1/40000 of measuring full range)				
A/D Converter	Gain		0.01 % of F.S./°C	
Stability with temperature	Zero *4		0.02 % of F.S./°C	
Input impedance	1 MΩ ± 5 %			
Maximum input voltage	Between (+) / (-) terminal	60 V p-p		
	Between channels	60 V p-p		
	Between channel / GND	60 V p-p		
Maximum voltage	Between channels	350 V p-p (1 minute)		
	Between channel / GND	350 V p-p (1 minute)		
Isolation	Between input / GND	Min. 50 MΩ (at 500 V DC)		
Common-mode rejection ratio	Min. 90 dB (50/60 Hz, Signal source impedance: Max. 300 Ω)			
Filter	Off, 2, 5, 10, 20, 40 (Moving average in selected number. When the sample is longer than 5 seconds, the data sampled in the sub-sample (5 seconds) will be used for creating the average value.)			
5V output	Driving the humidity sensor B-530, 1 channel			
External dimensions (W×D×H)	49 x 136 x 160 mm (Excluding protrusion)			
Weight	Approx. 770 g			

Voltage module specifications		Voltage	High Speed Voltage
Model number	GL7-V		GL7-HSV
Number of input channels	10 channels		4 channels
Input method	All channels isolated unbalanced input, Simultaneous sampling, Screw terminal		All channels isolated unbalanced input, Simultaneous sampling, BNC connector
Sampling speed (interval)	1 k Samples/s to 1 Sample/h (1ms to 1h)		1 M Samples/s to 1 Sample/h (1μs to 1h)
Measurement range	100, 200, 500 mV, 1, 2, 5, 10, 20, 50, 100 V, and 1-5 V/F.S.		
Measurement accuracy*5	± 0.25 % of F.S.		
A/D Converter	Successive Approximation type, 16 bits (effective resolution: 1/40000 of measuring full range)		
Stability with temperature	Gain	0.01 % of F.S./°C	
	Zero	0.02 % of F.S./°C	
Input impedance	1 MΩ ± 5 %		
Maximum input voltage	Between (+) / (-) terminal	100mV to 1V range: 60 V p-p, 2V to 100V range: 100 V p-p	
	Between channels	60 V p-p	
	Between channel / GND	60 V p-p	
Maximum voltage	Between channels	1000 V p-p (1 minute)	
	Between channel / GND	1000 V p-p (1 minute)	
Isolation	Between input / GND	Min. 50 MΩ (at 500 V DC)	
Common-mode rejection ratio	Min. 90 dB (50/60 Hz, Signal source impedance: Max. 300 Ω)		
Frequency response	DC to 1 k Hz (at +1/-3 dB)		DC to 2 k Hz (at +1/-3 dB)
Filter (Low pass)	Off, Line(1.5Hz), 5, 50, 500 Hz (-3dB, 6dB/oct)		Off, Line(1.5Hz), 5, 50, 500, 5k, 50k Hz (-3dB, 6dB/oct)
External dimensions (W×D×H)	49 x 136 x 160 mm (Excluding protrusion)		
Weight	Approx. 840 g		Approx. 740 g

Logic/Pulse Module Specifications			
Model number	GL7-L/P		
Number of input channels	16 channels		
Input method	All channels common ground, simultaneous sampling, Circular connector (4ch/connector)		
Sampling speed	Logic mode	Up to 1 M Samples/s (1μs interval)	
	Pulse mode	Up to 10 k Samples/s (100μs interval)	
Measurement mode	Selecting of the Logic input mode or Pulse input mode *6		
Mode	Pulse	Rotation count (RPM), Accumulating count, Instant count	
Rotation count (RPM)	Function	Counting the number of pulses per sampling interval and then it is converted to RPM	
	Range	50, 500, 5000, 50 k, 500 k, 5 M, 50 M, 500 M rpm/F.S.	
Accumulating count	Function	Accumulating the number of pulses from the start of measurement	
	Range	50, 500, 5 k, 50 k, 500 k, 5 M, 50 M, 500 M counts/F.S.	
Instant count	Function	Counting the number of pulses per sampling interval (count is reset at each sampling)	
	Range	50, 500, 5 k, 50 k, 500 k, 5 M, 50 M, 500 M counts/F.S.	
Max. input frequency	1 M Hz		
Max. number of count	15 M counts (24 bits counter is used)		
Input signal	Voltage range	0 to +24 V (common ground)	
	Signal type	Contact (Relay), Open collector, Voltage	
	Threshold	Approx. 2.5 V	
	Hysteresis	Approx. 0.5 V (2.5 V to 3 V)	
Filter	Off or On (-3 dB at 50 Hz)		
External dimensions (W×D×H)	49 x 136 x 160 mm (Excluding protrusion)		
Weight	Approx. 700 g		

- Notes:
- Using optional humidity sensor (B-530).
 - Subject to the following conditions:
 - Room Temperature is 23°C ±5°C.
 - When 30 minutes or more have elapsed after power was turned on.
 - Filter is set to 10.
 - Sampling rate is set to 1s with 10 channels.
 - GND terminal is connected to ground.
 - Wire size of thermocouple to use is 0.32mm in T type, 0.65mm in other type.
 - It is effective when the 10, 20, 50ms sampling is used. When the sampling is slower than 100ms, it is not effective by executing the Zero calibration periodically.
 - Subject to the following conditions:
 - Room Temperature is 23°C ±5°C.
 - When 30 minutes or more have elapsed after power was turned on.
 - Filter is set to Line (1.5 Hz).
 - Sampling rate is set to 1s.
 - GND terminal is connected to ground.
 - The measuring mode is set in each module (16 channels). When the module is used in the Logic, up to 7 modules can be attached to one main module. (max. 112 ch) When the module is used in the Pulse, up to 2 modules can be attached to one main module. (max. 32 ch) The amplifier module can be attached to up to 10 modules. The maximum number of channels is limited to up to 112 channels.

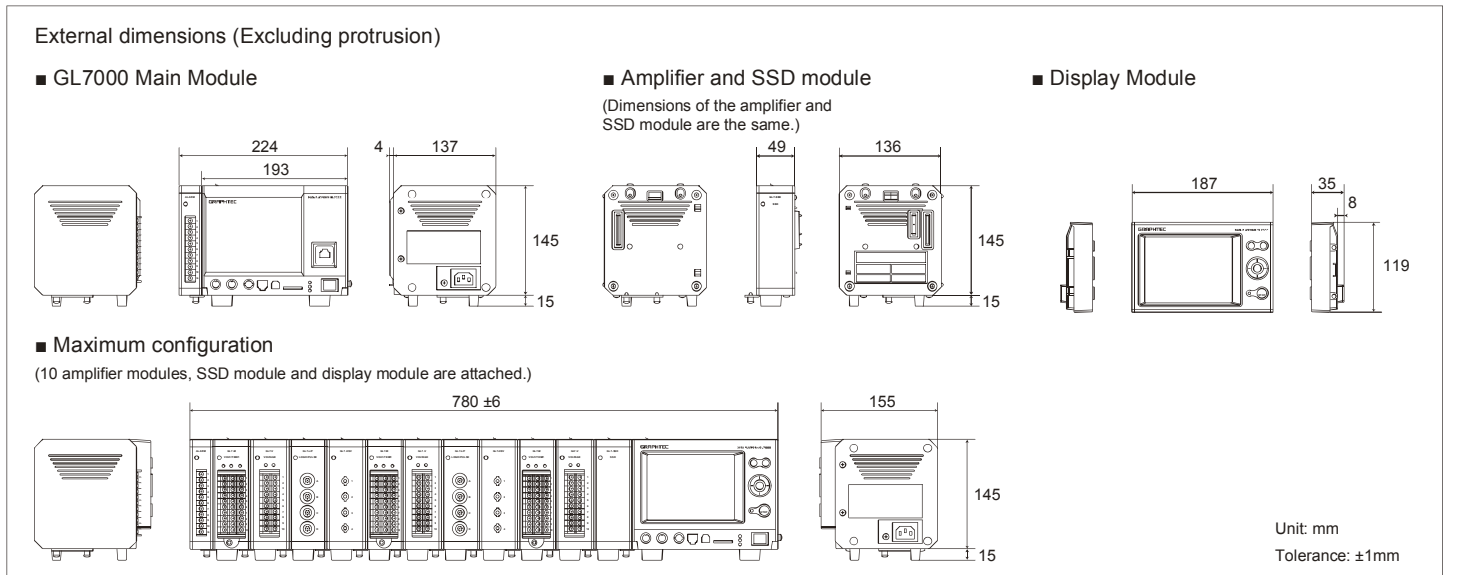

Brand names and product names listed in this brochure are the trademarks or registered trademarks of their respective owners. Specifications are subject to change without notice.



GRAPHTEC
Graphtec Corporation

503-10 Shinano-cho, Totsuka-ku, Yokohama 244-8503, Japan
Tel : +81-45-825-6250 Fax : +81-45-825-6396
Email : webinfo@graphtec.co.jp

Website <http://www.graphteccorp.com>



ER231206_AD Vol.09